

**Double Roman**  
Code: GTV-DR

For use with:

Marley Double Roman  
Redland Double Roman  
Sandtoft Double Roman  
Russell Double Roman  
Lagan Double Roll

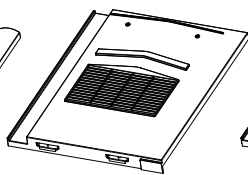

**Non-Profile**  
Code: GTV-NP

For use with:

Marley Modern  
Redland Mini Stonewold  
Sandtoft Calderdale\*  
Russell Grampian  
Lagan Flat

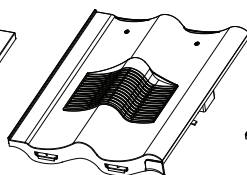

**Double Pantile**  
Code: GTV-DP

For use with:

Marley Mendip  
Redland Grovebury  
Sandtoft Double Pantile  
Russell Pennine

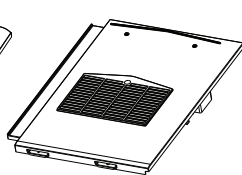

**Thin Leading Edge**  
Code: GTV-TE

For use with:

Marley Edgemere  
Redland Richmond  
Sandtoft TLE  
Russell Galloway  
Lagan Elite

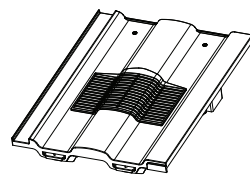

**Castellated**  
Code: GTV-CS

For use with:

Marley Ludlow Major  
Redland Renown  
Sandtoft Lindum  
Russell Cheviot  
Lagan Square Top

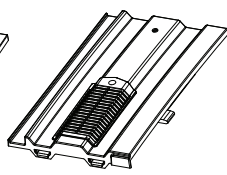

**Mini Castellated**  
Code: GTV-MC

For use with:

Marley Ludlow Plus  
Redland 49  
Sandtoft Standard attern  
Forticrete V2

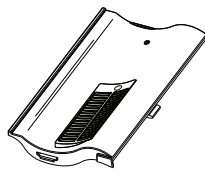

**Single Pantile**  
Code: GTV-SP

For use with:

Marley Anglia  
Redland Fenland  
Sandtoft Shire

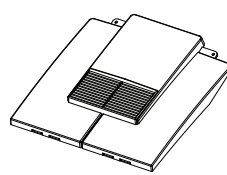

**Plain Tile**  
Code: GTV-PT

For use with:

Concrete and traditional  
clay plain tiles.  
Granulated finish vents  
are also available.

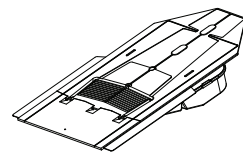

**Slate Vent (In-Line)**  
Code: GILSV30-25

For use with:

Man-made and  
natural slates.  
600 x 300mm  
in size.

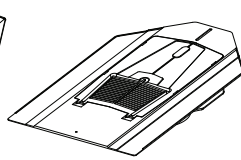

**Slate Vent (In-Line)**  
Code: GILSV25-20

For use with:

Man-made and  
natural slates.  
400 x 200mm up to  
500 x 250mm.

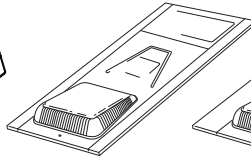

**Slate Vent (Hooded)**  
Code: GRSV30-25

For use with:

Man-made and  
natural slates.  
500 x 250mm up to  
600 x 300mm.

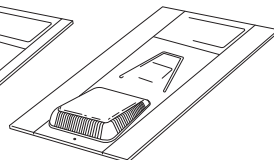

**Slate Vent (Hooded)**  
Code: GRSV45

For use with:

Man-made and  
natural slates.  
500 x 250mm up to  
600 x 450mm.

\*Non-Profile vent will suit the original Calderdale tile, for the Calderdale Edge tile use the Flat Edge tile vent.

**Manthorpe Building Products Limited**

Manthorpe House, Brittain Drive, Codnor Gate Business Park, Ripley, Derbyshire DE5 3ND  
T: (01773) 303 000 F: (01773) 303 300 E: mbp.care@manthorpebp.co.uk  
W: www.manthorpebp.co.uk



# Manthorpe

## Interlocking Plain Tile Ventilator

### Fitting Instructions

MBP1105d

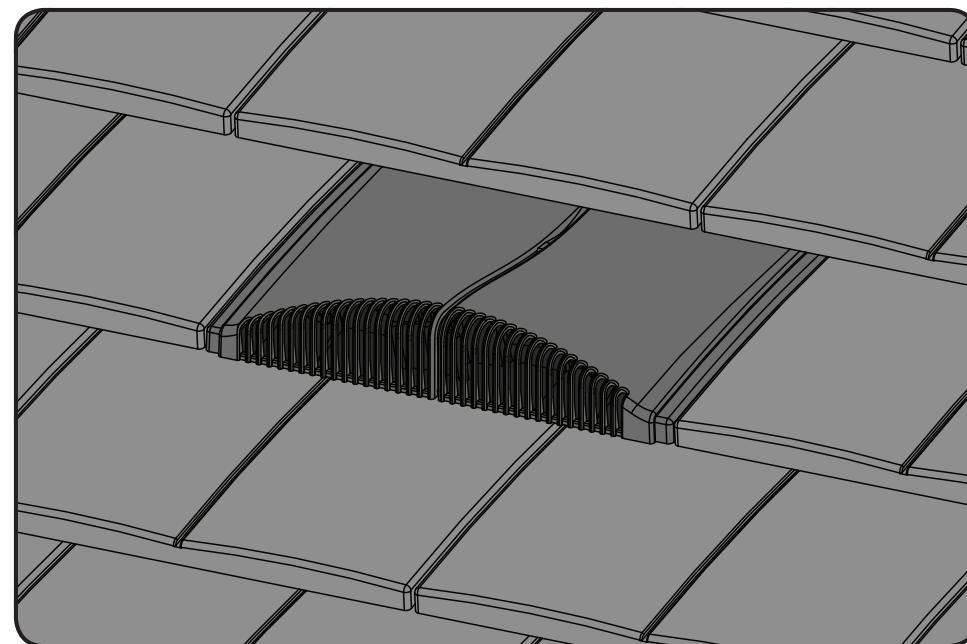

## Interlocking Plain Tile Ventilator Installation Requirements:

- **Minimum Roof Pitch:** 22.5° DO NOT INSTALL BELOW THIS PITCH
- **Maximum Headlap:** 95 mm
- **Product Airflow:** 6,000 mm<sup>2</sup>

The tile vent should not be used to extract hot exhaust gases, nor be placed close to other potentially hot elements of the roof structure.

When ventilating at high level, the vent should not be placed on the course directly below the ridge tile.

For mechanical extraction, use the Manthorpe **GTV-AD Flexi Pipe Adaptor** and one of the **GRPA Flexible Pipe Range** in conjunction with the vent.

<b>Required roofspace ventilation:</b>	5,000mm <sup>2</sup> /M	10,000mm <sup>2</sup> /M	25,000mm <sup>2</sup> /M
<b>Install one tile ventilator every:</b>	1200mm	600mm	240mm

## Installation

1. Prepare the roof tiles in the conventional manner, tiling up to the point at which you require the tile ventilator to be positioned.

**NOTE:** The vent cannot be placed directly over a rafter.

2. Directly below the batten that the vent is to be placed on, mark out a rectangle 60mm x 260mm wide on the underlay in line with the centre of where the vent will sit. Also mark an X in the centre of this rectangle from corner to corner.

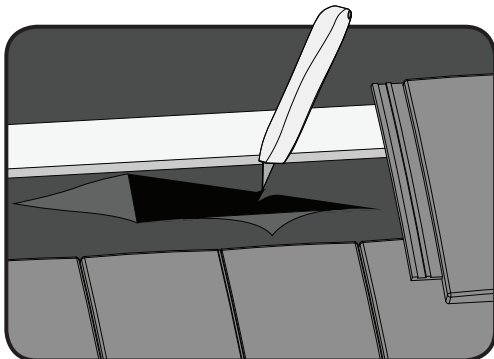
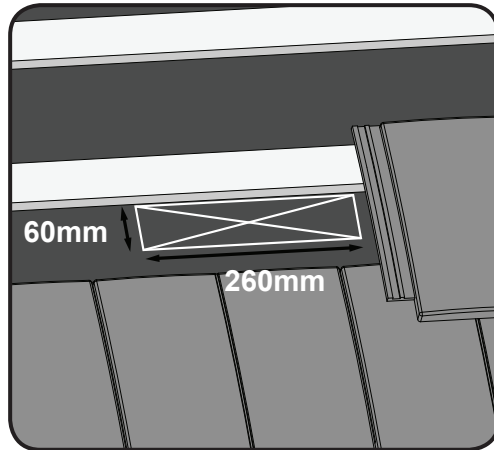

3. Cut the underlay along the diagonal X lines and fold back the triangular tabs to reveal the spigot opening.



4. Fold the top tab tight up against the batten above it and secure it in position with a staple or tack.

The ventilator can be used in conjunction with all 3 styles of interlocking plain tile; the **Redland DuoPlain**, **Marley Ashmore** and **Forticrete Gemini**. See step 5 for details on aligning the vent for use with your chosen profile.

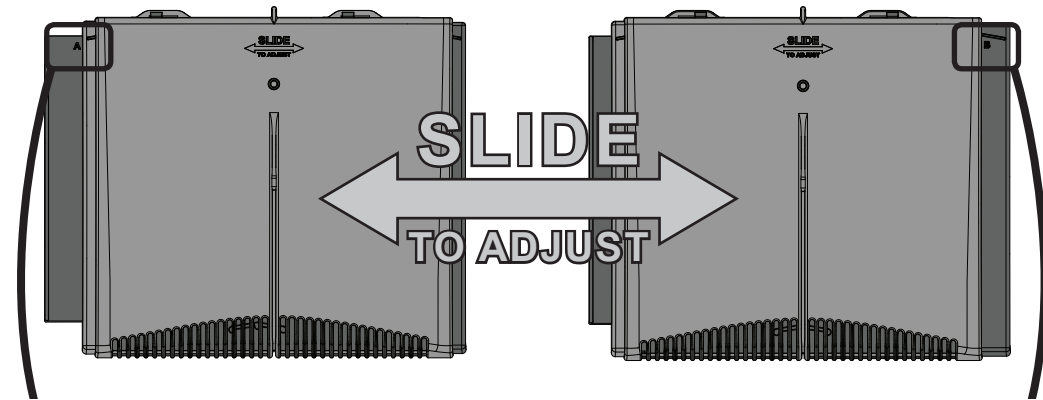

**Position A for use with DuoPlain & Ashmore**

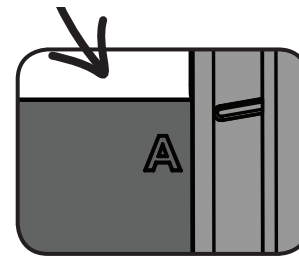

**Position B for use with the Forticrete Gemini**

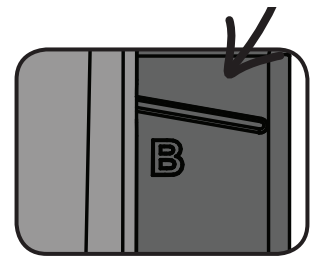

5. After identifying the correct position for your style of tile, hold the vent by the interlock and slide the upper surface to the left or right using the top tab to uncover the designated letter for your profile. Slide right for position A, slide left for position B.

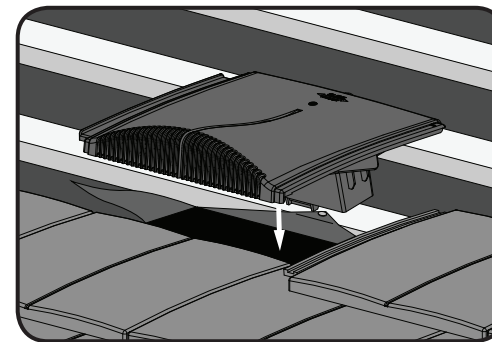

6. Insert the vent into the correct position on the roof, making sure the spigot passes fully through the felt so it is accessible from the loftspace. Ensure that the tile vent sits square and securely over the interlock of the adjacent tile.

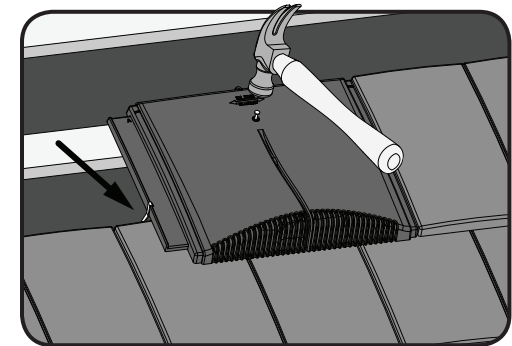

7. Nail the vent down into position by perforating the skin over the pre-formed hole. Clip the vent in place using the tile manufacturers specified clips for the relevant tile. Once fixed, continue tiling in the normal manner.