

The Complete Range Profiles available from the Manthorpe range of tile ventilators

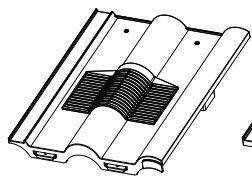

Double Roman
Code: GTV-DR

For use with:

Marley Double Roman
Redland Double Roman
Sandtoft Double Roman
Russell Double Roman
Lagan Double Roll

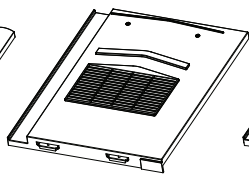

Non-Profile
Code: GTV-NP

For use with:

Marley Modern
Redland Mini Stonewold
Sandtoft Caderdale
Russell Grampian
Lagan Flat

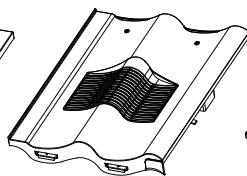

Double Pantile
Code: GTV-DP

For use with:

Marley Mendip
Redland Grovebury
Sandtoft Double Pantile
Russell Pennine

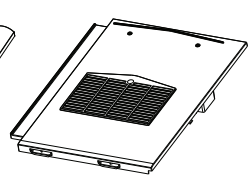

Thin Leading Edge
Code: GTV-TE

For use with:

Marley Edgemere
Redland Richmond
Sandtoft TLE
Russell Galloway
Lagan Elite

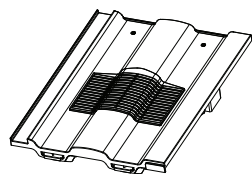

Castellated
Code: GTV-CS

For use with:

Marley Ludlow Major
Redland Renown
Sandtoft Lindum
Russell Cheviot
Lagan Square Top

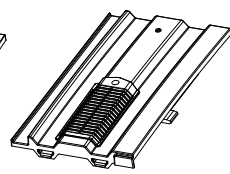

Mini Castellated
Code: GTV-MC

For use with:

Marley Ludlow Plus
Redland 49
Sandtoft Standard attern
Forticrete V2

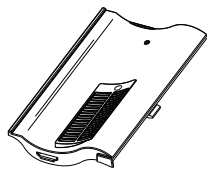

Single Pantile
Code: GTV-SP

For use with:

Marley Anglia
Redland Fenland
Sandtoft Shire

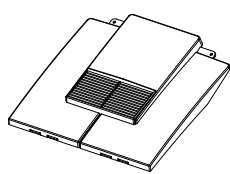

Plain Tile
Code: GTV-PT

For use with:

Concrete and traditional clay plain tiles.
Granulated finish vents are also available.

Manthorpe

Tile Ventilator Range

Single Pantile Ventilator

Fitting Instructions

MBP1078c

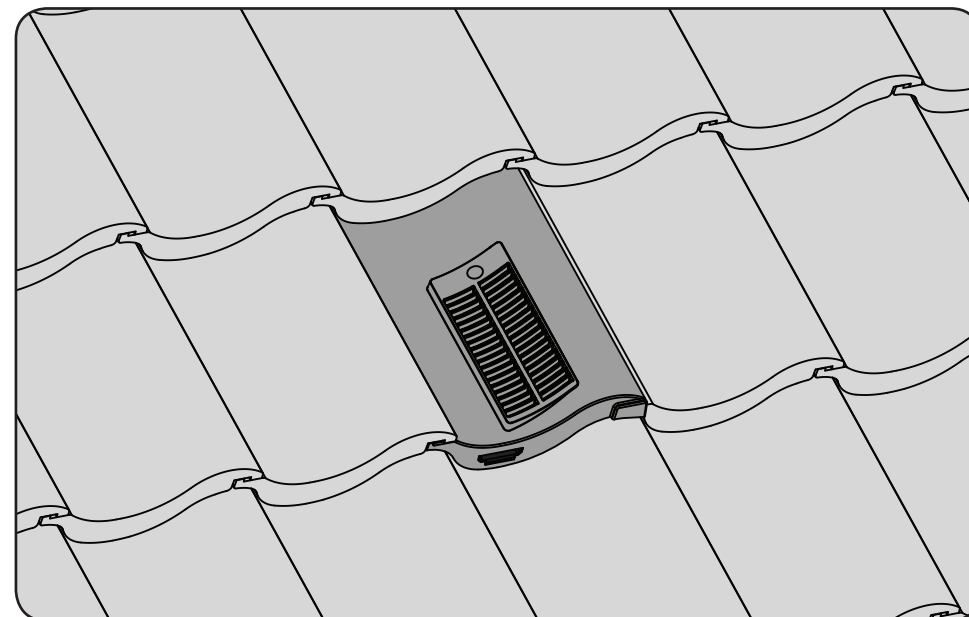

Other products from the Manthorpe Range include Cavity Trays, Cavity Closer, Loft Doors, Access Panels, Roof Ventilation, Through Wall Ventilation, Drainage Channels, Dry Fix Roofing and Air Leakage Products.



Manthorpe Building Products Limited

Manthorpe House, Brittain Drive, Codnor Gate Business Park, Ripley, Derbyshire DE5 3ND

T: (01773) 303 000 F: (01773) 303 300 E: customercare@manthorpebp.co.uk

W: <http://www.manthorpebp.co.uk>

Single Pantile Ventilator Installation Requirements:

- **Minimum Roof Pitch:** 20°
- **Maximum Headlap:** 125 mm
- **Product Airflow:** 5,000 mm²

The tile vent should not be used to extract hot exhaust gases, nor be placed close to other potentially hot elements, such as flues or chimneys.

When ventilating at high level, the vent should not be placed on the course directly below the ridge tile.

For mechanical extraction or ducted systems, you can connect one of the **GRPA Flexible Pipe Range** directly on to the 4" outlet on the base of the vent.

Installation

1. Prepare the roof tiles in the conventional manner up to the point at which you require the tile ventilator to be positioned.

2. Directly below the batten that the vent is to be placed on, mark out a rectangle 140mm x 140mm wide on the underlay in line with the centre of the tile below. Also mark an X in the centre of this rectangle from corner to corner.

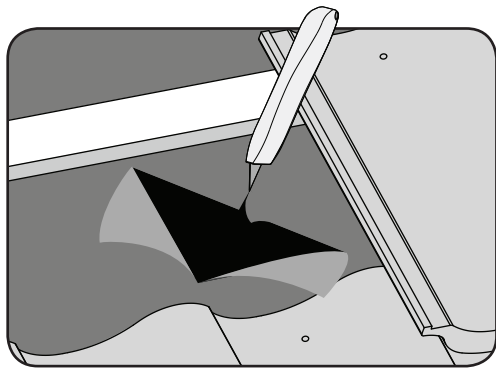
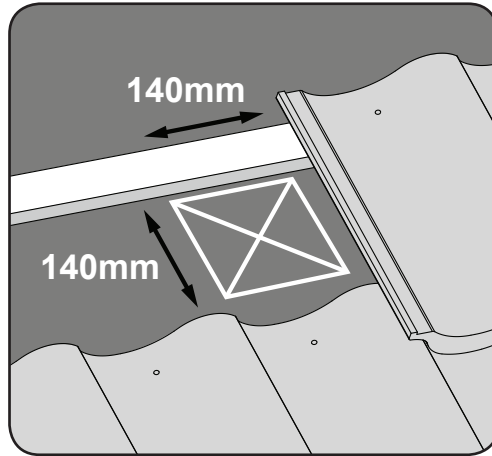

3. Cut the underlay along the diagonal X lines and fold back the triangular tabs to reveal the spigot opening. Fold back and tuck the loose tabs below the adjacent tiles where applicable.

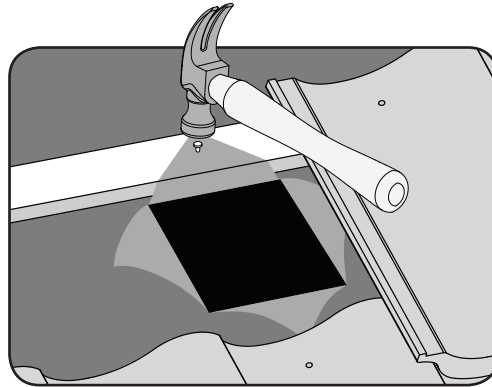

4. Fold the top tab tight up against the batten above it and secure it in position with a staple or tack. Ensure that you align the fixing off centre so it does not clash with the tile fixing point.

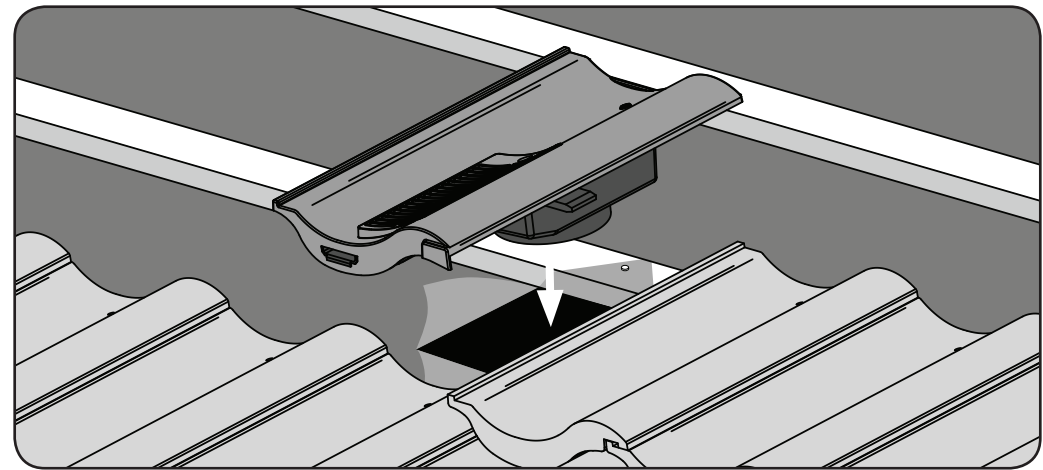

5. Insert the vent into position, ensuring that the tile aligns correctly with the interlock, and that the wind uplift tab is secured below the adjacent tile. It is important to make sure that the spigot passes fully through the underlay so it is accessible from the loftspace.

6. Nail the vent down into position by perforating the skin over the pre-formed hole. It is recommended that you also clip the vent in place using the tile manufacturers specified clips for their single pantile format. Once fixed, continue tiling in the normal manner.

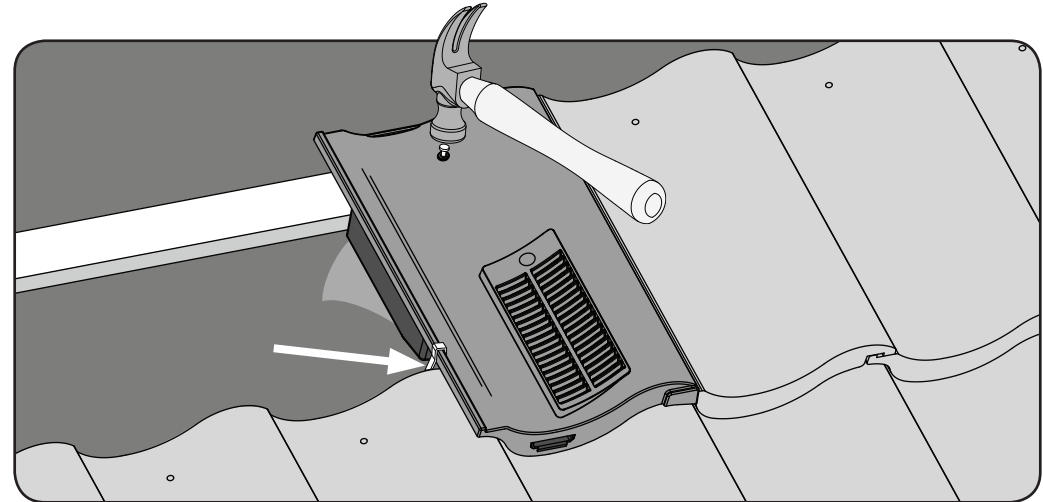

7. If you wish to use the terminal for mechanical extraction or ducted ventilation systems, first install the vent then locate the outlet within the loft space. The GTV-SP has a circular 4" outlet on its base which can connect directly on to a Manthorpe GRPA Flexible Pipe or to other standard 4" diameter ducting. To fit, simply align the GRPA pipe with the outlet and push over, securing it in place with a jubilee clip.

NOTE: To comply with the BRE Report 262, it is recommended that the GRPA pipes and other ducting should be fully insulated along its total length in the roof space to avoid the risk of internal condensation.